

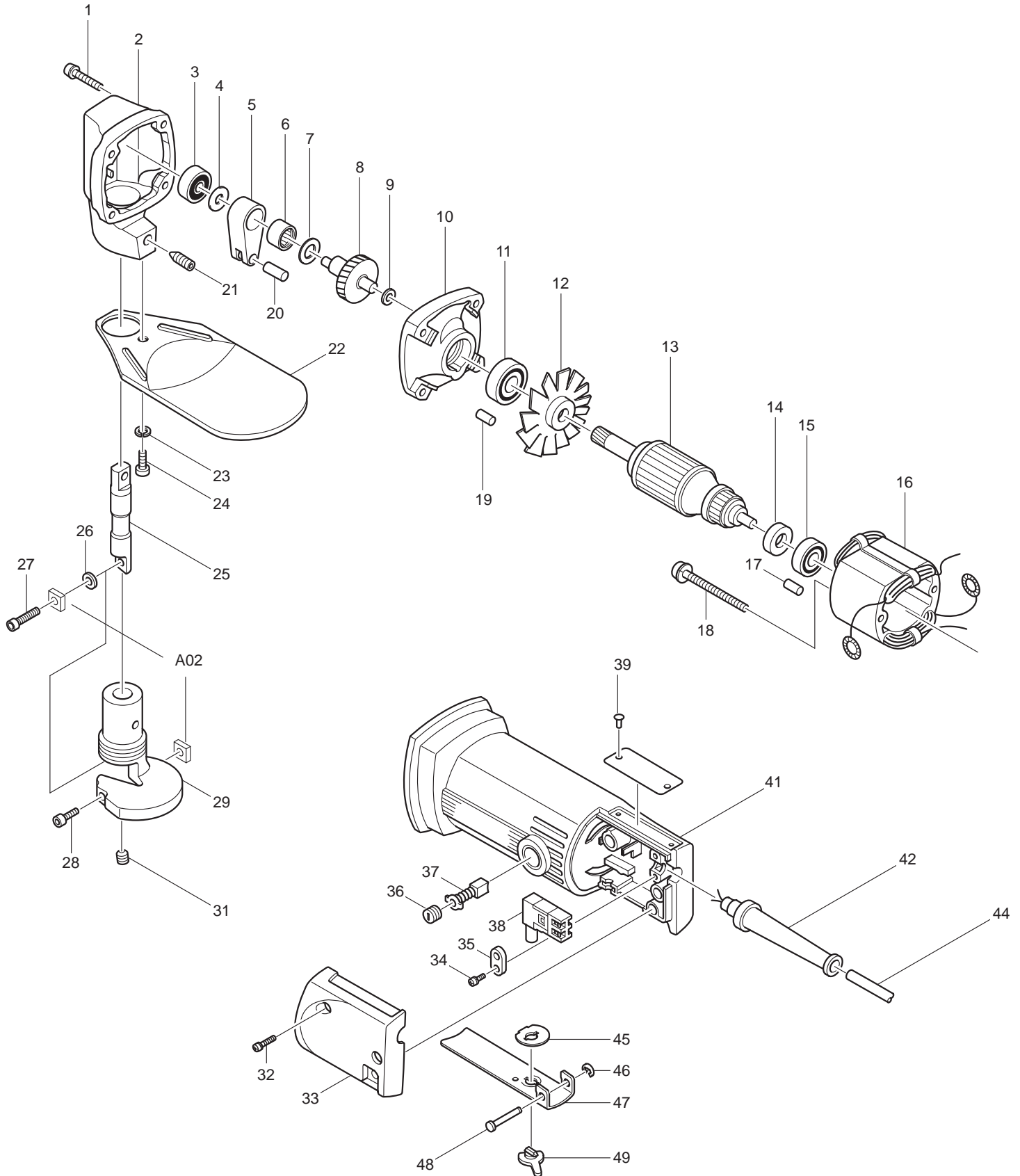

12 - 2010
JS1600
16 GAUGE SHEAR



Item No.	Type	Sub	Part No.	Description (* see Service changes on Page 4)	Qty	Unit
1			911156-3	PAN HEAD SCREW M4X30	4	PC.
2			156725-5	GEAR HOUSING	1	PC.
		INC.	817658-6	CAUTION LABEL	1	PC.
3			210025-8	BALL BEARING 627LLB	1	PC.
4			253823-7	FLAT WASHER 7	1	PC.
5			331151-1	ROD	1	PC.
6			212063-6	NEEDLE BEARING 1012	1	PC.
7			253758-2	FLAT WASHER 10	1	PC.
8			153138-1	CRANK SHAFT COMPLETE	1	PC.
9			253715-0	FLAT WASHER 6	1	PC.
10			156731-0	GEAR HOUSING COVER	1	PC.
		INC.	212011-5	NEEDLE BEARING 609	1	PC.
		INC.		Item No. 19		
11			211033-2	BALL BEARING 608LB	1	PC.
12			241081-7	FAN 58	1	PC.
13			511431-3	ARMATURE ASS'Y 115V (OLD# 611431-4)	1	PC.
		INC.		Item No. 11,12,14,15		
14			681614-0	INSULATION WASHER	1	PC.
15			211028-5	BALL BEARING 627LB	1	PC.
16			521416-1	FIELD ASS'Y 115V (OLD# 621416-2)	1	PC.
		INC.	654018-9	RING TERMINAL	2	PC.
		INC.	654501-6	CONNECTOR P-1.25	2	PC.
17			263002-9	RUBBER PIN 4	1	PC.
18	3		266147-2	* TAPPING SCREW 4X55	2	PC.
19			263002-9	RUBBER PIN 4	1	PC.
20			256110-3	PIN 6	1	PC.
21			913427-4	SET SCREW M8X16	1	PC.
22			341676-7	PROTECTOR	1	PC.
23			942101-7	* SPRING WASHER 5 (Old)	1	PC.
24	2		922206-9	* HEX. SOCKET HEAD BOLT M5X10	1	PC.
25			321311-3	BLADE HOLDER	1	PC.
26			253334-2	THIN WASHER 5	1	PC.
27			922112-8	HEX. SOCKET HEAD BOLT M4X10	1	PC.
28			922127-5	* HEX. SOCKET HEAD BOLT M4X16	1	PC.
29			311717-3	* YOKE (OLD# 311500-8)	1	PC.
30			931102-0	* HEX NUT M4 (OLD# 252036-7) (OLD)	2	PC.
31			251986-3	H.S.SET SCREW(FLAT POINT)M6X6	1	PC.
32			911158-9	PAN HEAD SCREW M4X30	2	PC.
33			411827-7	SWITCH COVER	1	PC.
34			911133-5	PAN HEAD SCREW M4X18 (OLD# 911131-9)	2	PC.
35			687001-1	STRAIN RELIEF (For SJT CORD)	1	PC.
		Opt.	687002-9	STRAIN RELIEF (For SJ CORD) (OPTION)	1	PC.
36			643550-8	BRUSH HOLDER CAP 5-8	2	PC.
37	1		191947-0	CARBON BRUSH CB-76 2PC/SET (W/O ORIGIN)	1	SET
	2		194972-0	CARBON BRUSH CB-76 2PC/SET (W/ ORIGIN)	1	SET
	Opt.		181501-8	AUTO CUT-OFF CARBON BRUSH CB-61 2PC/SET (W/O ORIGIN)	1	SET
38			651821-9	SWITCH ZGM-54	1	PC.
39			953106-2	RIVET 0-5 (For Steel Name Plate) (OLD)	2	PC.
41			157720-8	* MOTOR HOUSING	1	PC.
		INC.	643557-4	* BRUSH HOLDER 5-8	2	PC.
		INC.		* Item No. 17		
42			682500-8	CORD GUARD 8.5-72	1	PC.
44			664002-6	CORD W/PLUG 2P-18-2.0M, SJT	1	PC.
	Opt.		660002-4	CORD W/PLUG 2P-18-2.0M, SJ (OPTION)	1	PC.
45			232062-2	LEAF SPRING	1	PC.
46			961017-7	STOP RING E-3	1	PC.

Item No.	Type	Sub	Part No.	Description (* see Service changes on Page 4)	Qty	Unit
47			133433-5	SWITCH LEVER ASS'Y (OLD# 341651-3)	1	PC.
		INC.		Item No. 45,49		
48			256626-8	PIN 4	1	PC.
49			411784-9	SAFETY LOCK	1	PC.
50			410048-8	WRENCH HOLDER 3.4 (No Illustration)	1	PC.
100			911002-0	P.H. SCREW M3X6 (For Switch)	4	PC.
<u>ACCESSORIES</u>						
A01			783201-2	HEX. WRENCH 3	1	PC.
A02			191383-0	* SHEAR BLADE SET	1	SET

SERVICE CHANGES

1. Changes on Yoke and Shear Blade Set

Item No.	Description	Type 1	Type 2	Type 3
28	H.S.H Bolt	922137-2 (M4X20) (N/L/A)		922127-5 (M4X16)
29	Yoke	311717-3 (or 311500-8)		
		4.8mm hole for blade	5.3mm hole for blade	
30	Hex Nut	931102-0 (OLD 252036-7)		-----
A02	Shear Blade Set	191384-8 (N/L/A)		191383-0
		No Screw Thread	W/ Screw Thread	

Above parts are completely interchangeable as a set.

Type 1

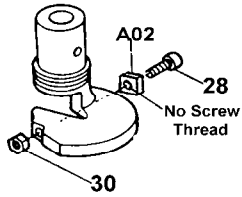

Type 2

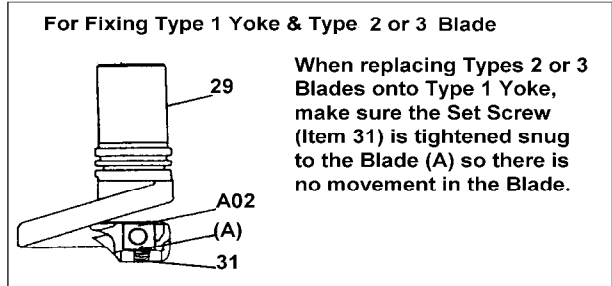
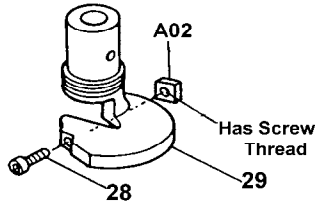

2. Changes on Motor Housing and Screw

Item No.	Description	Type 1	Type 2	Type 3
18	Screw	925183-4 (Hex Bolt M4X55)	265891-8 (Tapping BT 4X55)	266147-2 (Tapping Screw 4X55)
41	Motor Housing	156766-1 (N/L/A)	157720-8	

Above parts are completely interchangeable as a set.

Type 1

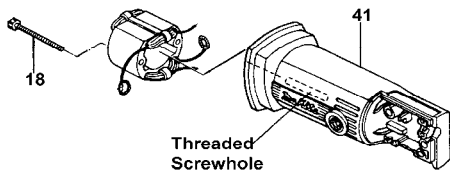

Type 2

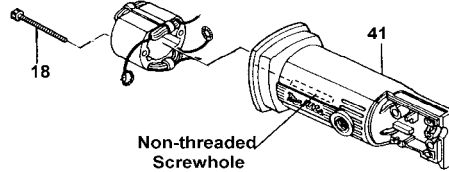

3. Change on Hex.Socket Heat Bolt

Item No.	Description	Type 1	Type 2
24	H.S.H Bolt M5X10	922207-7	922206-9
23	Spring Washer 5	942101-7	-----

Above parts are completely interchangeable as a set.

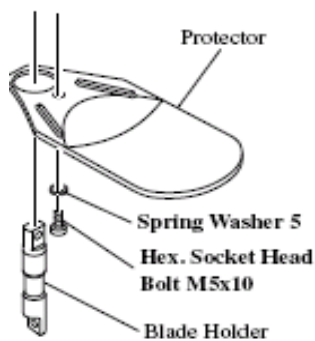

Type1

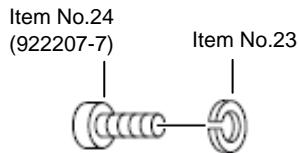

Type2

